

- (19) J. Dyke, N. Jonathan, E. Lee, and A. Morris, *J. Chem. Soc., Faraday Trans. 2*, **72**, 1385 (1976).
 (20) W. F. Egelhoff, D. L. Perry, and J. W. Linnett, *J. Electron Spectrosc. Relat. Phenom.*, **5**, 339 (1974).
 (21) A. Schweig, N. Thon, and H. Vermeer, *J. Am. Chem. Soc.*, **101**, 80 (1979).
 (22) F. Carnovale, T. H. Gan, and J. B. Peel, *J. Electron Spectrosc. Relat. Phenom.*, **16**, 87 (1979).
 (23) J. B. Peel and G. D. Willett, *J. Chem. Soc., Faraday Trans. 2*, **71**, 1799 (1975).
 (24) F. Carnovale, E. Nagy-Felsobuki, J. B. Peel, and G. D. Willett, *J. Electron Spectrosc. Relat. Phenom.*, **14**, 163 (1978).
 (25) E. Nagy-Felsobuki and J. B. Peel, *J. Electron Spectrosc. Relat. Phenom.*, **15**, 61 (1979).
 (26) M. K. Livett, E. Nagy-Felsobuki, J. B. Peel, and G. D. Willett, *Inorg. Chem.*, **17**, 1608 (1978).
 (27) E. Nagy-Felsobuki and J. B. Peel, *J. Chem. Soc., Faraday Trans. 2*, **74**, 1927 (1978).
 (28) D. Colbourne, D. C. Frost, C. A. McDowell, and N. P. C. Westwood, *J. Chem. Phys.*, **68**, 3574 (1978).
 (29) D. Colbourne, D. C. Frost, C. A. McDowell, and N. P. C. Westwood, *J. Chem. Phys.*, **69**, 1078 (1978).
 (30) A. Hinchliffe, *Adv. Mol. Relaxation Interact. Processes*, **13**, 309 (1978).
 (31) C. A. Coulson and G. N. Robertson, *Proc. R. Soc. London, Ser. A*, **337**, 167 (1974); **342**, 289 (1975).
 (32) F. Carnovale, T. H. Gan, and J. B. Peel, *Aust. J. Chem.*, **32**, 719 (1979).

Theoretical Study of the Reaction of Water with the 1,3 Dipoles Fulminic Acid and Acetonitrile Oxide. Concerted Reactions with a Proton Slide at the Transition State¹

M.-T. Nguyen,^{2a} M. Sana,^{2a} G. Leroy,^{*2a} K. J. Dignam,^{2b} and A. F. Hegarty^{*2b}

Contribution from the Departments of Chemistry, Universite Catholique de Louvain, 1348 Louvain-la-Neuve, Belgium, and University College, Cork, Ireland.

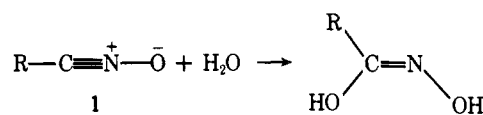
Received February 20, 1979

Abstract: The ease of deformation of fulminic acid (HCNO) and acetonitrile oxide (CH₃CNO), the formation of hydrogen-bonded complexes with water, and the reaction pathway with water as nucleophile (RCNO + H₂O → RC(OH)=NOH) have been studied using the ab initio method. The calculations were carried out using Roothaan's LCAO-SCF-MO and the supermolecule technique, using Pople's STO-3G basis set. The reaction pathways were studied by allowing six angles and five bond distances to vary, using the distance *R* between the carbon of the 1,3 dipole and the oxygen of the water molecule as reaction coordinate. Fulminic acid is most easily bent in the *E* (or trans) direction and this is the configuration induced in the transition state as the water molecule approaches (thus determining the stereospecific nature of the reaction, as observed experimentally). As the transition state is reached (*R* = 1.85 Å) there is no energy barrier for the transfer of a proton from the oxygen of the attacking water molecule to that of the fulminic acid. The stereospecificity of the reaction thus ensures that the two oxygens are correctly oriented to facilitate this "proton slide". There are no intermediates on the reaction pathway which can thus be described as a concerted but asynchronous (4π + 2s) reaction. Acetonitrile oxide is less reactive (activation energy of 29.2 relative to 23.5 kcal mol⁻¹ for fulminic acid) and the transition state is reached later with both more proton transfer and deformation of the 1,3 dipole. With HCNO two H-bonded complexes can be formed with water (which do not lie on the reaction pathway); the relative stabilities and the isomerization between the conformations of product hydroxyformaldoxime are also reported.

Nitrile oxides (**1**), which are propargyl-type 1,3 dipoles, react not only with unsaturated substrates (2π systems) to give five-membered heterocycles,³ but also with nucleophilic reagents, including both anionic (such as HO⁻, CH₃O⁻, N₃⁻, etc.) and neutral (H₂O, ROH, R₂NH, etc.) examples.⁴ This latter addition leads to the formation of open-chain oximes as products.

The mechanism of the reaction of alkenes with 1,3 dipoles has been the subject of intensive study and there now appears to be agreement that this is generally a concerted reaction in which the bonds to the two termini of the dipolarophile are formed at or about the same time.³ The reaction of RCNO with nucleophiles occurs by attack at carbon; however, these reactions also appear to be stereospecific in that only one of the two possible oxime isomers is invariably formed.⁴ We have previously reported⁵ that this experimental result is confirmed in a model reaction—that of hydroxide ion (HO⁻) with fulminic acid (HCNO). In this case it was shown that the *Z* form of the product was determined kinetically at the transition state—the configuration of the product was independent of any interaction between the oxygen of the 1,3 dipole and the incoming nucleophile (which was minimal).

In neutral solution (pH < 8), water reacts with benzonitrile oxide (**1**, R = Ph) and related 1,3 dipoles.⁴ The reaction is slow



(*t*_{1/2} > 100 min) and was shown to be pH independent. Substituent effects suggest that water is also acting as a nucleophilic reagent.

We have now carried out a theoretical study on this reaction using both fulminic acid (**1**, R = H) and acetonitrile oxide (**1**, R = CH₃) as substrates. We were particularly interested in this case in the timing of proton-transfer relative to the movement of heavy atoms and in the possibility that both processes could be concerted.

Methods of Calculation

The calculations were carried out by the ab initio method of Roothaan.⁶ In each case we have utilized the STO-3G basis set of Pople^{7a} with the GAUSSIAN-70 program.^{7b} This basis set is sufficiently reliable for studying reactions between neutral molecules. Moreover, it is not necessary to include a limited configurational interaction in order to obtain qualitatively significant results, since the number of pairs of electrons is conserved in the course of reaction. We have adopted the

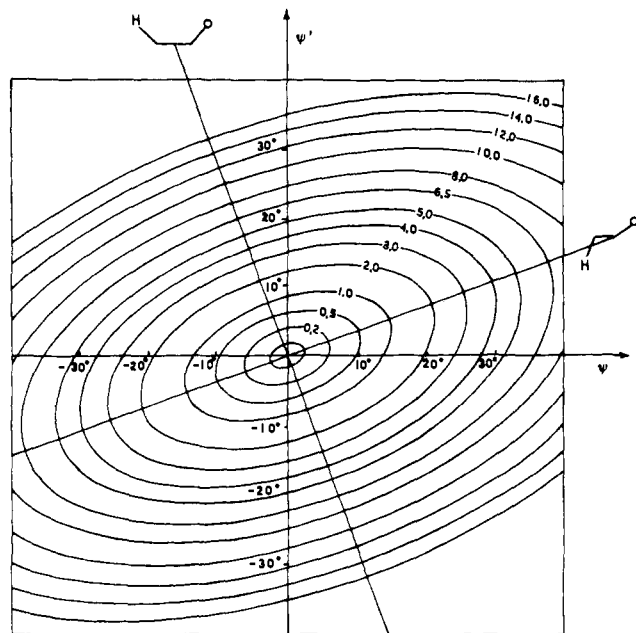


Figure 1. Potential energy hypersurface for the deformation of fulminic acid.

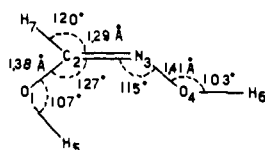
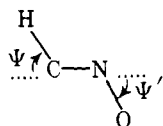


Figure 2. Optimized geometry of the Z, s-cis, s-trans form of hydroxyformaldoxime.

classical view of the supermolecule. Finally, charge centroids were obtained by the method of localization of Foster-Boys,^{8a} using Boyloc's^{8b} program.

Results and Discussion

Addition of Water to Fulminic Acid. A. Ability of Reactants to Undergo Deformation. The optimized geometries of the reactants have already been described.⁹ We have calculated the energy required to produce angular deformations in the fulminic acid molecule (since such geometric changes are induced in the reaction with nucleophiles). The angles Ψ and Ψ' are defined as follows.



We have obtained energy values for different angles between $+40$ and -40° . Using a second-order regression¹⁰ the energy potential of the surface, $E(\Psi, \Psi')$, in kcal mol⁻¹, can be expressed in the following quantitative way:

$$E(\Psi, \Psi') = -103754.016 + 0.005172\Psi^2 - 0.006548\Psi\Psi' + 0.013058\Psi'^2$$

This equation describes an ellipsoid centered on the origin and with an axis of $\Psi = 19.842^\circ$ relative to the main axis (Figure 1). The principal values of the second derivative matrix of this equation are 0.028 48 (for the largest) and 0.007 98 (for the second). This potential energy surface shows that the fulminic acid is linear in its equilibrium geometry. Such result has already been obtained by Houk,²² even with a 4-31G basis set. The Boys localization, where the CN bond is quasi-triple, gives

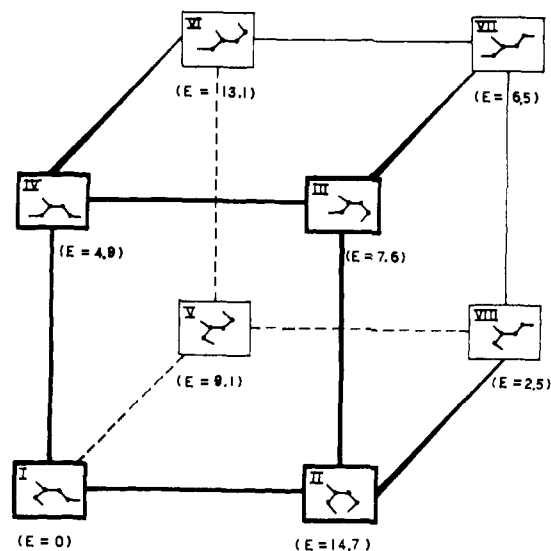


Figure 3. Relative energies (kcal mol⁻¹) of the different forms of hydroxyformaldoxime.

a picture of HCNO in perfect agreement with this structure.

The grand axis of the ellipsoid corresponds to a deformation of fulminic acid toward the *E* (or trans) form. A deformation of 10° on this axis (comprising $\Psi = 9.4^\circ$ and $\Psi' = 3.4^\circ$) only requires 0.80 kcal mol⁻¹ while a deformation along the lesser axis (comprising $\Psi = -3.4^\circ$ and $\Psi' = 9.4^\circ$) requires 2.85 kcal mol⁻¹. In summary, the *E* (or trans) deformation with respect to the C=N bond is far more readily achieved. Such observations have been also pointed out by Houk^{20,21} and are important in the reactivity of the fulminic acid.²²

Using an analogous procedure we have calculated the energy associated with the angle (ξ) of the water molecule. The following equation describes the energy (in kcal mol⁻¹) associated with deformation of this angle; the minimum arises when ξ is 99.968° .

$$E(\xi) = -46890.725 - 10.069634\xi + 0.072348\xi^2 + 0.0001466\xi^3$$

B. Isomers of Hydroxyformaldoxime. Hydroxyformaldoxime can exist in either *Z* or *E* configurations with respect to the C₂N₃ double bond and in the conformations s-cis and s-trans with respect to the single bonds O₁C₂ and N₃O₄. We have optimized its geometry while maintaining constant the CH and OH bond lengths ($R_{CH} = 1.07 \text{ \AA}$ and $R_{OH} = 0.99 \text{ \AA}$). As an example, we have given in Figure 2 the structure obtained for the Z, s-cis, s-trans form.

The bond lengths remain constant in each form and the valence angles vary by no more than a few degrees. In Figure 3 we have compared the relative energies of the different structures of hydroxyformaldoxime. The respective stabilities depend on the equilibrium between the repulsive interactions between adjacent hydrogens and hydrogen-oxygen or hydrogen-nitrogen attractions.

We have also studied the s-cis-s-trans isomerization for the hydroxyformaldoxime in the *Z* configuration. Two mechanisms of isomerization are generally proposed¹¹ for this type of reaction: an out-of-plane rotation of the O-H or an inversion in the molecular plane. In Figure 4 are given definitions of the structural parameters considered. Tables I and II give the total energies calculated for the two reaction pathways for isomerization.

We have obtained an analytical form¹⁰ for these hypersurfaces using a development of a Fourier series in two dimensions, including in each direction in space (φ and φ' for rotation, δ

Table I. Isomerization s-Cis-s-Trans of (Z)-Hydroxyformaldoxime. Mechanism of Out-of-Plane Rotation ($E = -240. xxx$ au)

| φ , deg | -180 | -150 | -120 | -90 | -60 | -30 | 0 | 30 | 60 | 90 | 120 | 150 | 180 |
|-----------------|----------------------------|----------|----------|------------------------------|----------|----------|-----------------------------|----------|----------|----------------------------|----------|----------|----------------------------|
| -180 | 0.501 59 (I) | 0.498 41 | 0.492 66 | 0.483 12 ^a (X) | 0.483 58 | 0.479 72 | 0.477 67 (II) | 0.479 72 | 0.483 51 | 0.488 12 ^a (X) | 0.493 66 | 0.498 41 | 0.501 09 (I) |
| -150 | 0.497 63 | 0.495 53 | 0.489 58 | 0.484 25 | 0.481 50 | 0.480 30 | 0.479 58 | 0.480 30 | 0.482 94 | 0.485 64 | 0.489 30 | 0.494 57 | 0.497 63 |
| -120 | 0.491 24 | 0.453 77 | 0.462 17 | 0.477 56 | 0.478 91 | 0.481 00 | 0.481 38 | 0.481 01 | 0.479 22 | 0.478 18 | 0.483 29 | 0.483 58 | 0.491 24 |
| -50 | 0.488 34 ^a (XI) | 0.485 46 | 0.479 10 | 0.473 44 (XIII) ^b | 0.475 01 | 0.481 64 | 0.483 85 ^a (XII) | 0.481 75 | 0.476 65 | 0.475 91 | 0.480 39 | 0.483 86 | 0.483 34 ^a (XI) |
| -60 | 0.459 6 | 0.456 73 | 0.481 90 | 0.476 12 | 0.478 62 | 0.482 10 | 0.484 43 | 0.482 60 | 0.478 72 | 0.477 38 | 0.481 83 | 0.487 23 | 0.489 63 |
| -30 | 0.452 13 | 0.489 49 | 0.464 14 | 0.480 16 | 0.460 30 | 0.484 66 | 0.486 03 | 0.484 53 | 0.480 37 | 0.480 04 | 0.484 54 | 0.489 73 | 0.492 13 |
| 0 | 0.493 25 | 0.490 76 | 0.485 64 | 0.481 58 ^a (IX) | 0.483 03 | 0.486 07 | 0.489 00 | 0.486 07 | 0.483 03 | 0.481 58 ^a (IX) | 0.485 64 | 0.490 76 | 0.493 24 (IV) |
| 30 | 0.492 13 | 0.489 73 | 0.434 54 | 0.480 04 | 0.480 37 | 0.484 53 | 0.480 08 | 0.484 66 | 0.480 50 | 0.480 16 | 0.484 14 | 0.489 49 | 0.492 13 |
| 60 | 0.459 63 | 0.487 23 | 0.461 33 | 0.477 39 | 0.473 72 | 0.453 20 | 0.484 43 | 0.482 10 | 0.473 62 | 0.476 42 | 0.481 90 | 0.486 78 | 0.489 63 |
| 90 | 0.482 34 ^a (XI) | 0.485 36 | 0.480 39 | 0.475 91 (XIV) | 0.476 66 | 0.481 75 | 0.433 85 ^a (XII) | 0.481 64 | 0.475 07 | 0.473 44 | 0.479 10 | 0.485 65 | 0.480 36 ^a (XI) |
| 120 | 0.491 24 | 0.483 58 | 0.483 29 | 0.478 13 | 0.479 22 | 0.481 01 | 0.481 38 | 0.481 00 | 0.475 91 | 0.477 86 | 0.482 27 | 0.488 77 | 0.491 24 |
| 150 | 0.497 63 | 0.494 57 | 0.489 80 | 0.483 64 | 0.482 94 | 0.480 35 | 0.479 58 | 0.480 30 | 0.481 50 | 0.488 25 | 0.489 58 | 0.495 53 | 0.497 63 |
| 180 | 0.501 09 (I) | 0.498 41 | 0.493 55 | 0.483 12 ^a (X) | 0.483 51 | 0.479 72 | 0.477 67 (II) | 0.479 72 | 0.483 53 | 0.488 12 ^a (X) | 0.493 66 | 0.498 41 | 0.501 59 (I) |

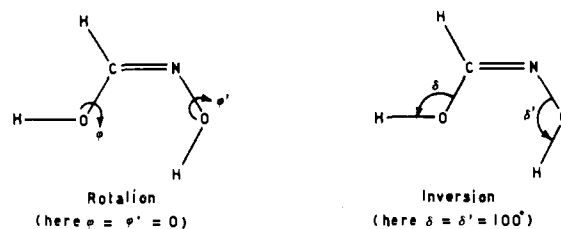
^a Activated complex.


Figure 4. Geometric parameters for the isomerization s-cis-s-trans form.

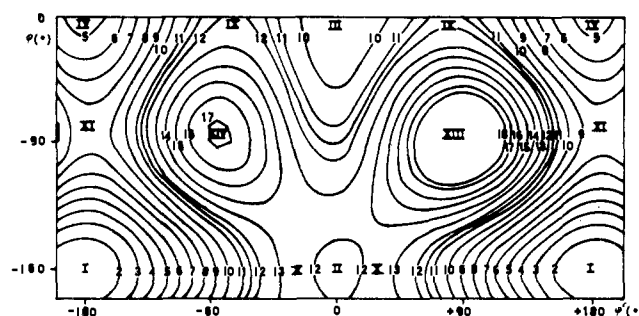


Figure 5. Potential energy diagram for the isomerization s-cis-s-trans of hydroxyformaldoxime by an out-of-plane rotation.

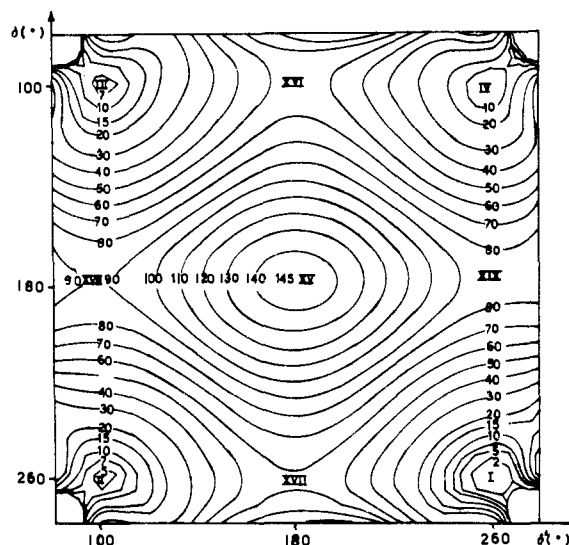


Figure 6. Potential energy diagram for the isomerization s-cis-s-trans of hydroxyformaldoxime by an in-plane inversion mechanism.

and δ' for inversion) five even functions ($1.0, \cos \alpha, \cos 2\alpha, \cos 3\alpha, \cos 4\alpha$, with $\alpha = \varphi, \varphi', \delta, \text{ or } \delta'$) and three uneven functions ($\sin \alpha, \sin 2\alpha, \text{ and } \sin 3\alpha$). The development of the series then contains 64 basic functions; the multiple regression coefficients obtained are better than 0.992 and the residual variance is less than 0.8 kcal. In Figures 5 and 6 are given two-dimensional illustrations of the potential energy hypersurfaces. The main points are summarized in Figure 7; we have included in the same figure the associated energies. The structures I-IV are minima while IX-XII and XVI-XIX are minimax and structures XIII-XV are maxima on the potential energy hypersurfaces.

In summary, rotations about the single bonds C_2-O_1 , and N_3-O_4 are facile nuclear motions and require activation energies of only a few kcal mol⁻¹ (less than 8 kcal mol⁻¹). These results are in line with other reported studies¹² on s-cis-s-trans isomerization. On the other hand, the inversion barriers are considerably higher (60-80 kcal/mol). Such re-

Table II. Isomerization s-Cis-s-Trans of (Z)-Hydroxyformaldoxime. Mechanism of In-Plane Inversion ($E = -240.xxx$ au)

| δ , deg | δ' , deg | | | | | | | | |
|----------------|-------------------------------|----------|----------|----------|------------------------------|----------|----------|----------|-----------------------------|
| | 100 | 120 | 140 | 160 | 180 | 200 | 220 | 240 | 260 |
| 100 | 0.489 00 (III) | 0.477 02 | 0.437 21 | 0.386 22 | 0.358 68 ^a (XVI) | 0.379 05 | 0.430 35 | 0.475 45 | 0.493 25 (IV) |
| 120 | 0.480 43 | 0.470 48 | 0.429 95 | 0.378 46 | 0.350 29 | 0.371 22 | 0.422 76 | 0.468 08 | 0.484 63 |
| 140 | 0.452 27 | 0.439 80 | 0.400 12 | 0.347 25 | 0.318 68 | 0.340 00 | 0.392 07 | 0.437 06 | 0.453 64 |
| 160 | 0.418 65 | 0.405 85 | 0.364 53 | 0.312 66 | 0.284 09 | 0.305 80 | 0.357 48 | 0.402 89 | 0.419 33 |
| 180 | 0.399 15 ^a (XVIII) | 0.388 27 | 0.348 51 | 0.297 64 | 0.269 66 (XV) | 0.291 75 | 0.343 45 | 0.388 77 | 0.405 98 ^a (XIX) |
| 200 | 0.410 22 | 0.401 65 | 0.362 75 | 0.312 80 | 0.285 83 | 0.308 86 | 0.360 68 | 0.405 68 | 0.422 47 |
| 220 | 0.441 65 | 0.434 50 | 0.395 35 | 0.347 93 | 0.321 36 | 0.345 88 | 0.399 80 | 0.441 83 | 0.458 46 |
| 240 | 0.468 51 | 0.464 26 | 0.428 27 | 0.379 20 | 0.354 66 | 0.379 44 | 0.430 71 | 0.475 01 | 0.491 09 |
| 260 | 0.477 67 (II) | 0.468 87 | 0.434 97 | 0.388 62 | 0.347 41 ^a (XVII) | 0.393 39 | 0.443 67 | 0.485 96 | 0.501 59 (I) |

^a Activated complex.

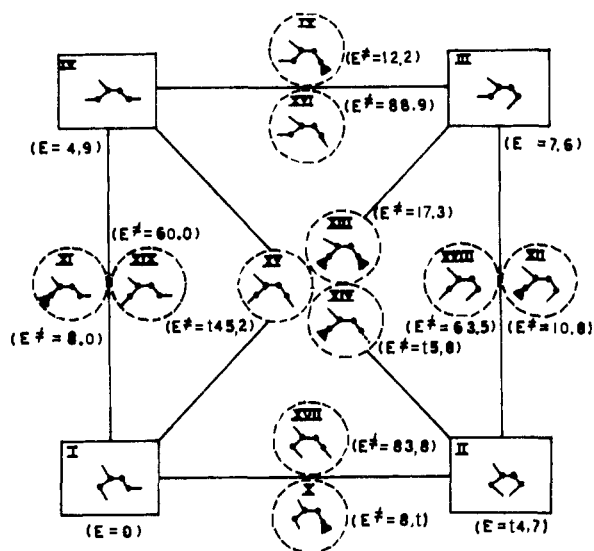


Figure 7. The s-cis-s-trans isomerization of Z-formaldoxime (ΔE in kcal mol⁻¹).

sults are probably at least in part an artifact of the STO-3G basis set, which is known to overestimate the activation energy of the inversion process.²³

C. Water-Fulminic Acid Complexes. The addition reaction of fulminic acid and water may be preceded by the formation of a molecular complex. The electrostatic potential map¹³ ($V(M)$) for fulminic acid (Figure 8) shows the presence of an electrophilic region ($V > 0$) about the hydrogen atom and a nucleophilic region ($V < 0$) at the oxygen atom. The minima of electrostatic potential are placed on the perimeter of the base of a cone whose apex is at the oxygen atom and whose axis of revolution is the axis HCNO. The aperture angle of this cone is 48.2° and the distance between the oxygen and the potential minima is 2.21 Å. This circumference then has an electrostatic potential of -63.3 kcal mol⁻¹.

The potential energy curve calculated is given in Figure 9. The displacement of the water molecule about the fulminic acid molecule leads at all times to stabilization, and the change from one complex to the other results in the rotation of the water molecule during its displacement along the axis of HCNO. The general characteristics of the complexes are given in Table III.

Using the supermolecule technique, we have sought the existence of molecular complexes. Keeping the internal geometry of the isolated reactants unchanged, we have displaced a water molecule about the fulminic acid molecule searching for the relative orientations which were most favorable for the two molecules. In each case, the planar structure is the most stable. Two stable molecular complexes are obtained, one resulting from nucleophilic attack by water on the hydrogen atom

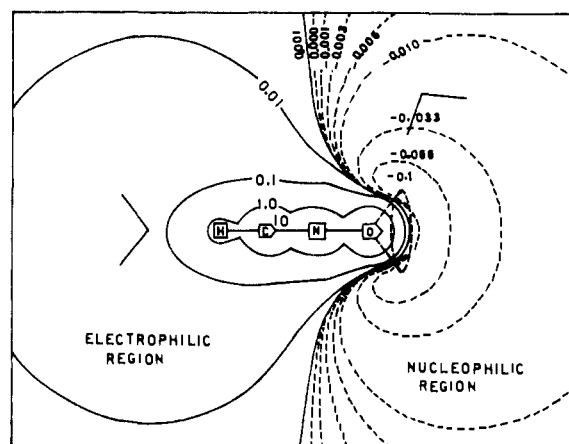


Figure 8. Potential energy diagram of the fulminic acid molecule and the complexation sites of water.

Table III. Characteristics of the Water-Fulminic Acid Complexes

| complex | $r_{O \cdots H}$, Å | ΔH_f , kcal/mol | μ , D | $t^*_{H_2O}$, c ⁻ |
|---------------------------|----------------------|-------------------------|-----------|-------------------------------|
| H ₂ O ··· HCNO | 1.75 | -8.4 | 6.5 | -0.046 |
| HCNO ··· H ₂ O | 1.90 | -4.5 | 3.0 | 0.031 |

of the fulminic acid and possessing C_{2v} symmetry, the other resulting from electrophilic attack of water on the oxygen atom of fulminic acid with an angle of attack of 70°. In Figure 8 we have represented the nuclear structures of the two complexes and superimposed them on the electrostatic potential map of the fulminic acid molecule. As previously noted by others,¹⁴ the electrostatic potential map is a valuable tool in searching for complexation sites.

For the molecular complexes we have allowed relaxation of fulminic acid and water angles. Such a freedom does not modify the angles more than 2° and improves the energy by less than 3×10^{-5} au.

The results recall the heats of formation and the charge transfer obtained in the hydrogen-bonded complexes H₂O ··· H₂O¹⁵ and H₂O ··· HF.¹⁶ In sum, the oxygen atom acts as a nucleophilic center and the hydrogen atom as an electrophilic center. The carbon atom, which is also electrophilic ($\Delta E = 1.6$ kcal mol⁻¹), does not give rise to a minimum in the potential energy hypersurface. Because of this, the molecular complexes between water and fulminic acid do not appear on the reaction pathway for addition (formation of hydroxyformaldoxime).

d. Reaction Pathway for Addition. The reaction pathway for the addition of water to fulminic acid has been calculated as a function of the parameters listed (defined in Figure 10): α , O₁C₂N₃ angle; β , H₇C₂N₃ angle; γ , O₄N₃C₂ angle; θ , H₆O₁C₂ angle; μ , H₅O₁C₂ angle; ν , H₆O₄N₃ angle; r , O₁H₆ bond length; r' , H₆O₄ distance; r_{CN} , C₂N₃ bond length; r_{NO} , N₃O₄

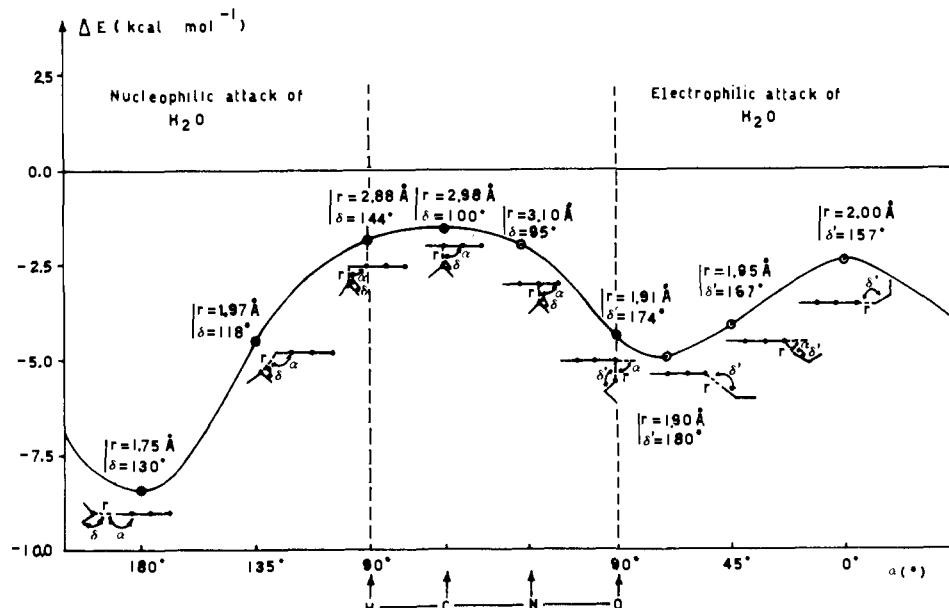


Figure 9. Structure and energy of the water-fulminic acid molecular complexes.

Table IV. Structure and Energy Characteristics along the Reaction Pathway for the Reaction between HCNO and H₂O

| $R, \text{Å}$ | α, deg | β, deg | γ, deg | μ, deg | θ, deg | ν, deg | $r_{\text{O}_1\text{N}_2}, \text{Å}$ | $r_{\text{N}_2\text{C}_3}, \text{Å}$ | $r, \text{Å}$ | $r', \text{Å}$ | E, av |
|-------------------|----------------------|---------------------|----------------------|-------------------|----------------------|-------------------|--------------------------------------|--------------------------------------|---------------|----------------|----------------|
| ∞ | 180 | 180 | 180 | | | | 1.30 | 1.16 | 0.99 | | -240.368 084 |
| 2.73 ^a | 180 | 180 | 180 | 130 | 130 | 8 | 1.30 | 1.16 | 0.99 | 5.87 | -240.371 452 |
| 2.50 | 115 | 175 | 175 | 155 | 101 | 50 | 1.30 | 1.16 | 0.99 | 3.85 | -240.357 193 |
| 2.25 | 112 | 170 | 170 | 155 | 101 | 54 | 1.30 | 1.16 | 0.99 | 3.43 | -240.350 634 |
| 2.10 | 110 | 165 | 165 | 155 | 101 | 58 | 1.31 | 1.17 | 0.99 | 3.15 | -240.343 113 |
| 2.05 | 110 | 160 | 160 | 155 | 101 | 61 | 1.31 | 1.18 | 0.99 | 3.01 | -240.339 032 |
| 2.00 | 110 | 155 | 155 | 155 | 101 | 64 | 1.32 | 1.19 | 0.99 | 2.88 | -240.334 366 |
| 1.95 | 110 | 152 | 151 | 154 | 101 | 67 | 1.32 | 1.20 | 0.99 | 2.76 | -240.329 430 |
| 1.90 | 110 | 150 | 147 | 153 | 101 | 69 | 1.33 | 1.21 | 0.99 | 2.64 | -240.324 698 |
| 1.85 ^b | 109 | 147 | 143 | 150 | 101 | 72 | 1.34 | 1.22 | 0.99 | 1.88 | -240.320 695 |
| 1.80 | 109 | 134 | 120 | 103 | 78 | 100 | 1.34 | 1.22 | 1.58 | 0.99 | -240.385 176 |
| 1.70 | 109 | 130 | 118 | 103 | 80 | 100 | 1.36 | 1.24 | 1.61 | 0.99 | -240.449 213 |
| 1.60 | 116 | 125 | 117 | 103 | 80 | 100 | 1.39 | 1.27 | 1.85 | 0.99 | -240.459 983 |
| 1.40 ^c | 121 | 120 | 115 | 106 | 82 | 100 | 1.41 | 1.29 | 1.93 | 0.99 | -240.488 983 |

^a Complex. ^b Transition state. ^c Product.

bond length; R , O₁C₂ distance. The distance R has been chosen as the reaction coordinate.

The calculations show that at all points on the reaction pathway all of the atoms remain in the same plane. In Table IV we have given the structural characteristics and energetics of the reaction pathway. Using the basis set STO-3G, the activation barrier, relative to the isolated reactants, is 23.5 kcal mol⁻¹ and the heat of reaction -82.1 kcal mol⁻¹.

In summary, the reaction occurs in two phases. The first is deformation of the fulminic acid in the *E* (trans) mode as the water approaches the carbon atom; this determines that the product will have the *Z* configuration (as experimentally observed in all analogous reactions).⁴ Thus the transition state is *i*. The second is transfer of the hydrogen atom H₆ from the oxygen O₁ toward the atom O₄, thus leading to the hydroxy-formaldoxime of structure *Z* (*s*-trans O₁C₂, *s*-cis N₃O₄) (*ii*).

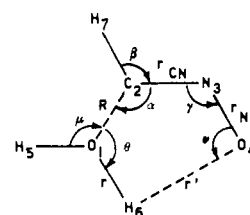
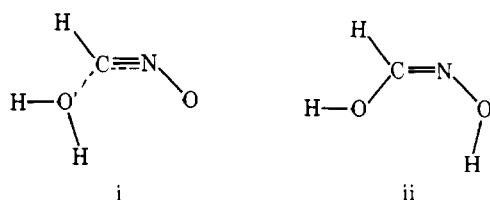


Figure 10. Geometric parameters for the addition of water to fulminic acid.

At the transition state the angles Ψ and Ψ' have the values of 33 and 37°, respectively. Such a deformation of the isolated fulminic acid molecule requires 15.5 kcal mol⁻¹. At the same time, the angle HOH (ξ) of the water molecule changes from 100 to 109°; this deformation requires 2.3 kcal mol⁻¹. Thus we can say that these deformations alone account for 17.8 kcal mol⁻¹, which represents 76% of the total height of the activation barrier.

We observe that the easier deformation mode of fulminic acid corresponds also to the molecular distortion during the addition of H₂O to HCNO. Such result has been also pointed out by Houk²² in the nucleophilic addition to acetylenes. Nevertheless, this is not a general rule; otherwise the approach

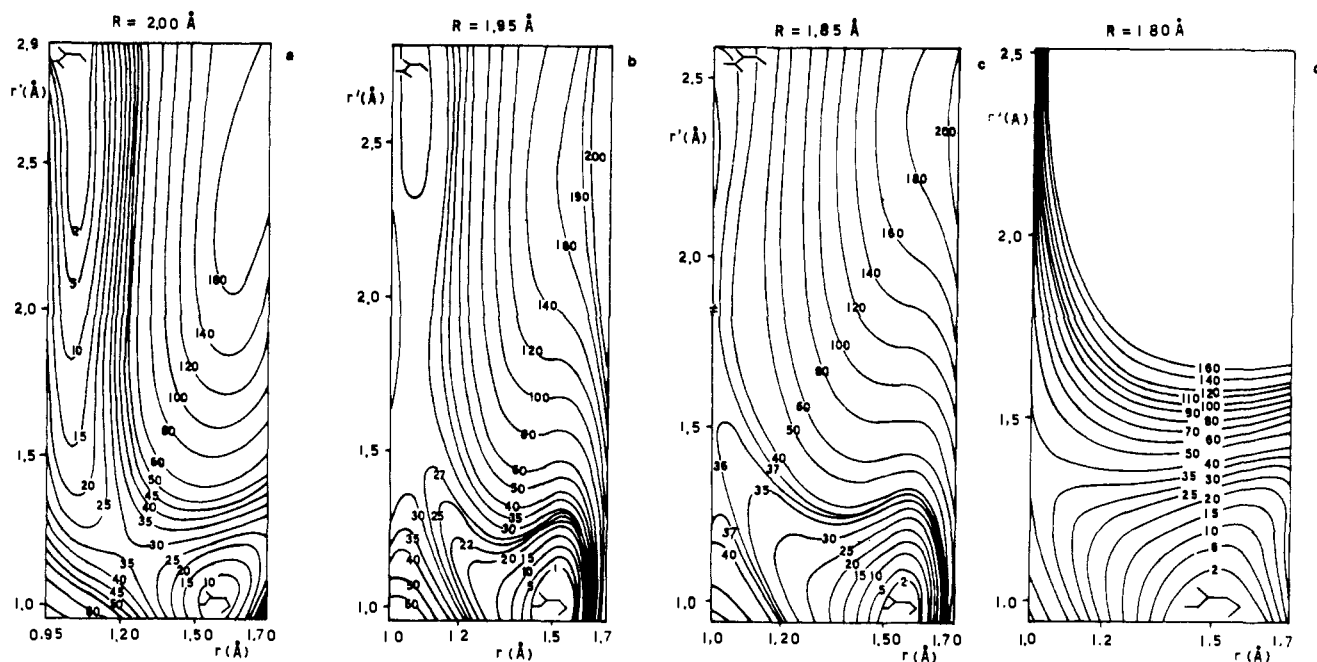
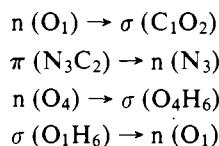


Figure 11. Evolution of the potential energy hypersurface along the reaction pathway for the reaction of HCNO with H₂O. Zero level with respect to reactants (kcal/mol⁻¹): (a) 14.9; (b) -8.2; (c) -13.3; (d) -17.0.

of diazomethane on ethylene would be in two parallel planes and not as found by some of us.²⁴

Figure 11 shows four sections in the potential energy hypersurface which correspond to the parameters R , r , and r' . It should be noted that at $R = 1.85$ Å a corridor is created in the hypersurface which permits the transfer of the hydrogen from one oxygen to the other. This corridor is a nearly flat valley connecting the point $R = 1.85$ Å, $r = 1.00$ Å, and $R' = 2.50$ Å with the transition state $R = 1.85$ Å, $r = 1.00$ Å, and $r' = 1.88$ Å.

The Boys localization method⁸ permits us to follow the electronic reorganization along the reaction pathway. On Figure 12, we have given the charge centroids calculated at different points on the pathway. The approach route followed by the water molecule is along the axis of one of its lone pairs. The effect of the dipolar deformation leads to the formation of a lone pair on the central nitrogen from the original triple bond C₂N₃. The rest of the electronic rearrangements occur after the transition state. Then the hydrogen H₆ is displaced progressively, passing from one lone pair on the oxygen O₁ to another lone pair on the oxygen O₄. In parallel, the formation of the intersystem σ bond O₁C₂ occurs. The electronic reorganization is summarized as follows:



Eight electrons in all are implicated in this reorganization; these occur in a cyclic way as shown schematically in Figure 13.

In Table V are given the changes in the overlap populations (P_{AB}) along the reaction pathway. According to the usual method^{17,18} we have transposed the magnitudes in terms of the energies of the bonds (E_{AB}) using the following relationships:

$$\begin{aligned} E_{\text{CO}} &= 1279.20P_{\text{CO}}^3 - 516.12P_{\text{CO}}^2 + 339.25P_{\text{CO}} \\ E_{\text{NO}} &= 571.77P_{\text{NO}}^3 + 120.97P_{\text{NO}}^2 + 231.50P_{\text{NO}} \\ E_{\text{OH}} &= 435.48P_{\text{OH}} \end{aligned}$$

The validity of these expressions has been discussed previously.¹⁸ Using these values it is possible to estimate the degree of evolution of the bonds in the transition state (T_{AB}) using the following relationship:

$$T_{AB}^{\ddagger} = 100 \frac{E_{AB}(\ddagger) - E_{AB}(\text{reactant})}{E_{AB}(\text{product}) - E_{AB}(\text{reactant})}$$

These quantities are also included in Table V. It is noted that at the transition state the C₂N₃ bond has changed to an important degree while the O₁C₂ bond is weak and the bond O₄H₆ is almost nonexistent.

If the asynchronization of the reaction is defined as

$$A = 100 \frac{T_{\text{C}_2\text{O}_1}^{\ddagger} - T_{\text{O}_4\text{H}_6}^{\ddagger}}{T_{\text{C}_2\text{O}_1}^{\ddagger} + T_{\text{O}_4\text{H}_6}^{\ddagger}}$$

then it can be calculated as 96.6%. Since there is no intermediate on the reaction pathway, the reaction can thus be defined as being concerted but asynchronous.

Finally we have observed that the charge transferred from the water molecule to fulminic acid is 0.15 electrons in the transition state. This charge transfer is clearly weaker than in the case of the addition of hydroxide ion to fulminic acid,⁵ but it occurs in the same direction (i.e., in that expected for a nucleophile addition).

Addition of Water to Acetonitrile Oxide

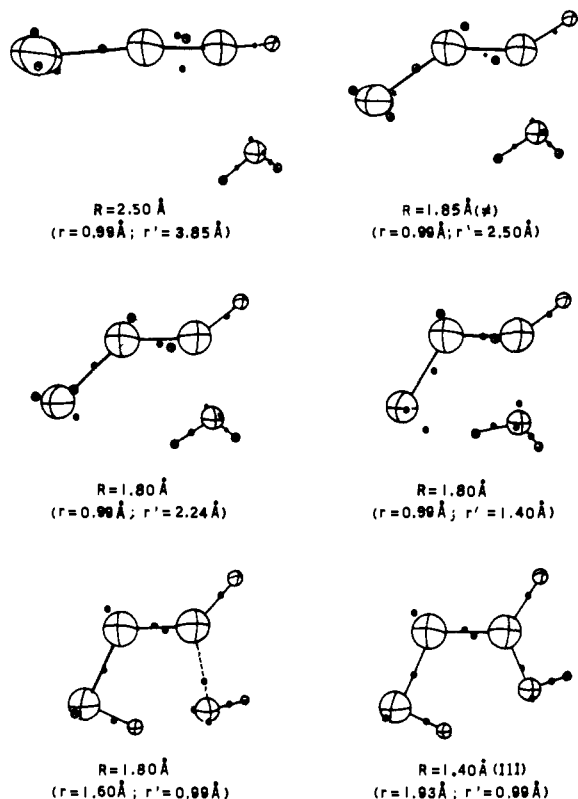
In order to obviate the formation of hydrogen-bonded complexes between the nucleophile and the H₇C₂ of fulminic acid (noted above with water and also reported⁵ with hydroxide ion) we have also studied the reaction of water with acetonitrile oxide (methyl fulminate). We were also interested in determining the effect of a substituent both on the deformability of the nitrile oxide and on the energy barrier for reaction.

We have as previously calculated the form of the hypersurface of the potential energy for deformation of the isolated acetonitrile oxide molecule. The analytical form¹⁰ at this hypersurface as a function of the angles of deformation Ψ and Ψ' is as follows (in kcal mol⁻¹):

$$\begin{aligned} E(\Psi, \Psi') &= -127966.33 + 0.00603\Psi^2 \\ &\quad - 0.00726\Psi\Psi' + 0.01308\Psi'^2 \end{aligned}$$

Table V. Overlap Populations, Bond Energies, and Degree of Evolution of Bonds at Several Points along the Reaction Pathway for Water-Fulminic Acid Reaction

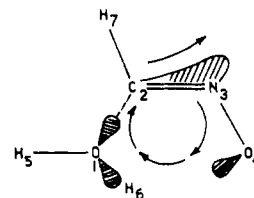
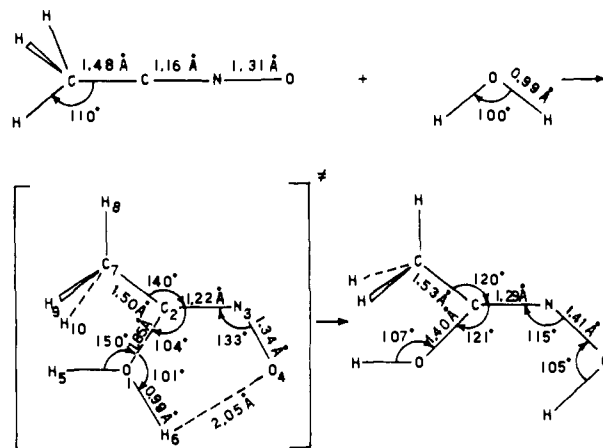
| | O ₁ -H ₆ | O ₁ -C ₂ | C ₂ -N ₃ | N ₃ -O ₄ | O ₄ -H ₅ |
|------------------|---|--------------------------------|--------------------------------|--------------------------------|--------------------------------|
| | Overlap Populations | | | | |
| reactants | 0.2539 | 0.0000 | 0.7463 | 0.2161 | 0.0000 |
| transition state | 0.2692 | 0.0446 | 0.6199 | 0.2048 | 0.0008 |
| product | 0.0066 | 0.2766 | 0.4935 | 0.2223 | 0.2477 |
| | Bond Energies (kcal mol ⁻¹) | | | | |
| reactants | 110.6 | 0.0 | 207.5 | 61.5 | 0.0 |
| transition state | 117.2 | 14.2 | 158.4 | 57.4 | 0.3 |
| product | 2.9 | 81.4 | 114.1 | 63.7 | 107.9 |
| | Degree of Bond Evolution (%) | | | | |
| transition state | | 17.5 | 52.6 | | 0.3 |

**Figure 12.** Evolution of the charge centroids along the reaction coordinate for addition of H₂O to HCNO. (The point of view is rotated by 30° for convenience.)

This expression is in the form of an ellipsoid, centered at the origin, whose major axis is inclined at 22.92° to the axis of Ψ . The principal values of the second derivative matrix are respectively 0.029 23 for the greater and 0.008 99 for the lesser.

The easiest mode of deformation of the acetonitrile oxide molecule is in the *E* (trans) mode with respect to the CN bond, as previously observed for fulminic acid. We would note, however, that the methyl group makes the molecular motions slightly more difficult. A deformation of 10° along the large axis (comprising $\Psi = 9.2^\circ$ and $\Psi' = 3.9^\circ$) requires 0.9 kcal mol⁻¹ and an analogous deformation along the small axis (comprising $\Psi = -3.9^\circ$ and $\Psi' = 9.2^\circ$) requires 2.92 kcal mol⁻¹.

We have also studied the reaction pathway for the addition of water to acetonitrile oxide. In Figure 14 we have gathered the structural characteristics for the reactants, the transition state, and the reaction product. The energy of activation for addition is calculated as 29.2 kcal mol⁻¹ and the heat of re-

**Figure 13.** Scheme for electronic rearrangement.**Figure 14.** Structural characteristics for the reactants, products, and transition state for the addition of water to acetonitrile oxide.

action as -78.3 kcal mol⁻¹. Thus the addition of water to acetonitrile oxide has an activation energy which is significantly higher than that observed for the addition to fulminic acid. Thus the methyl group has an overall deactivating effect.

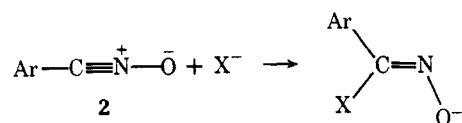
The deformation of the atoms of the acetonitrile oxide in going to the transition state calculated are 40° for the angle Ψ and 47° for the angles Ψ' (as compared with 33 and 37° for fulminic acid). Such a deformation of an isolated acetonitrile oxide requires 24.9 kcal mol⁻¹ ($E(40,47) - E(0,0)$). The parallel deformation of the water molecule (during which the angle changes from 100 to 109°) requires 2.3 kcal mol⁻¹. Most (ca. 93%) of the activation barrier consists of the energy required for the deformation of the isolated reactants as they approach the transition state. The difference between the activation barriers for the addition of water to fulminic acid and to acetonitrile oxide (5.7 kcal mol⁻¹) is not due to the effect of the methyl group on the ease of deformation of the isolated reactants; in effect, in order to produce a deformation of Ψ of 40° and Ψ' of 47° requires 24.8 kcal mol⁻¹ for fulminic acid (as against 24.9 kcal/mol for CH₃CNO) and on the other hand 15.6 kcal mol⁻¹ (against 15.5) is required to produce a deformation of 33° for Ψ and 37° for Ψ' . The influence of ease

Table VI. Overlap Populations, Bond Energies, and Degree of Evolution of Bonds at Several Points along the Reaction Pathway for the Water-Acetonitrile Oxide Reaction

| | O ₁ -H ₆ | O ₁ -C ₂ | C ₂ -N ₃ | N ₃ -O ₄ | O ₄ -H ₆ |
|------------------|---|--------------------------------|--------------------------------|--------------------------------|--------------------------------|
| | Overlap Populations | | | | |
| reactants | 0.2539 | 0.0000 | 0.7454 | 0.2115 | 0.0000 |
| transition state | 0.2721 | 0.0593 | 0.5844 | 0.2086 | 0.0089 |
| product | 0.0060 | 0.2773 | 0.4901 | 0.2193 | 0.2497 |
| | Bond Energies (kcal mol ⁻¹) | | | | |
| reactants | 110.6 | 0.0 | 207.1 | 59.8 | 0.0 |
| transition state | 118.5 | 18.6 | 145.5 | 58.7 | 3.9 |
| product | 2.6 | 81.7 | 113.0 | 62.6 | 108.7 |
| | Degree of Bond Evolution (%) | | | | |
| transition state | | 22.7 | 65.5 | | 3.6 |

of deformation of the reactants (when both are deformed to the same extent) is thus very small indeed (0.1 kcal mol⁻¹). The deactivating effect of the methyl group therefore probably arises from its electron-donating nature which tends to disfavor nucleophilic attack on the neighboring carbon; the transition state thus occurs later on the reaction coordinate, with a greater degree of deformation of the substrate.

This result is in line with experimental observations since the Hammett ρ values for the attack of nucleophiles on the substituted benzonitrile oxides **2** are always positive (e.g., ρ



= +0.57 (H₂O as nucleophile), +0.80 (HO⁻), and +0.75 (CH₃CO₂⁻)⁴ implying that electron donation reduces the reactivity.

In Table VI are noted the overlap populations, the energies, and the degrees of evolution of the bonds along the reaction pathway. The charge transfer measured on the basis of the Mulliken population is 0.16 to the transition state. One important point to note is that the intersystem bond O₄H₆, which is being formed, is more advanced in this case than for the reaction of fulminic acid. The asynchronization measured on this basis is 73%. The reaction therefore remains concerted but strongly asynchronous, and proton transfer also occurs at or just after the transition state through the corridor (see Figure 11) with no energy barrier.

Conclusions

The present work allows us to describe in some detail the mechanism of addition of water to fulminic acid and to acetonitrile oxide. The reaction is concerted (being overall 4 π + 2s) but highly asynchronous. The transfer of a proton from attacking water to the oxygen terminus of the 1,3 dipole begins at the transition state. This "proton slide"¹⁹ is predicted to occur without an energy barrier. The product of addition is an oxime of the configuration *Z* s-trans at the O₁C₂ bond and s-cis about the N₃O₄ bond. This form of hydroxyformaldoxime is not the most stable; obtained kinetically, it may evolve eventually to other (*Z* or *E*, different tautomeric) structures. However, such changes occur well after the transition state and do not affect our conclusions. The calculations also show the deactivating role of the *C*-methyl group, arising from steric

or electronic effects. It should be noted that the favorable internal proton transfer observed here may also occur either intermolecularly or via the intermediacy of other water molecules when the reaction is carried out in solution.

Acknowledgments. The Laboratoire de Chimie Quantique de l'Université Catholique de Louvain wishes to acknowledge financial assistance from OTAN for an international program of research on theoretical problems in chemical reactions. M.-T.N. thanks the Administration des Relations Culturelles Internationales for a research grant, and K.J.D. is grateful to the Department of Education for a Maintenance Grant for Research.

References and Notes

- (1) To be considered as part 4 of the series Reactions of 1,3-Dipoles in Aqueous Solution. Part 3: see ref 5.
- (2) (a) Laboratoire de Chimie Quantique, Place Louis Pasteur, 1-1348 Louvain-la-Neuve, Belgium; (b) Chemistry Department, University College, Cork, Ireland.
- (3) R. Huisgen, *Angew. Chem. Int. Ed. Engl.*, **2**, 565 (1963); *J. Org. Chem.*, **41**, 403 (1976).
- (4) K. J. Dignam, A. F. Hegarty, and P. L. Quain, *J. Chem. Soc., Perkin Trans. 2*, 1457 (1977); *J. Org. Chem.*, **43**, 388 (1978).
- (5) G. Leroy, M.-T. Nguyen, M. Sana, K. J. Dignam, and A. F. Hegarty, *J. Am. Chem. Soc.*, **101**, 1988 (1979).
- (6) C. C. J. Roothaan, *Rev. Mod. Phys.*, **23**, 69 (1951).
- (7) (a) W. J. Hehre, R. F. Stewart, and J. A. Pople, *J. Chem. Phys.*, **51**, 2657 (1969); (b) W. J. Hehre, W. A. Lathan, R. Ditchfield, M. D. Newton, and J. A. Pople, GAUSSIAN-70, QCPE No. 236.
- (8) (a) S. J. Boys, *Rev. Mod. Phys.*, **32**, 296 (1960); (b) D. Peters, BOYLOC, QCPE No. 330.
- (9) (a) D. Poppinger, *J. Am. Chem. Soc.*, **97**, 7486 (1975); *Aust. J. Chem.*, **29**, 465 (1976); (b) W. A. Lathan, W. J. Hehre, L. A. Curtiss, and J. A. Pople, *J. Am. Chem. Soc.*, **93**, 6378 (1971).
- (10) M. Sana, Program MULFRA (multifactor regression analysis), 1976.
- (11) D. Liotard, A. Dargelos, and M. Chaillet, *Theor. Chim. Acta*, **31**, 325 (1973); **38**, 79 (1975).
- (12) J. L. Villaveces, personal communication.
- (13) R. B. Bonaccorsi, C. Petrongolo, E. Scrocco, and J. Tomasi, *Theor. Chim. Acta*, **20**, 331 (1971).
- (14) G. Leroy, G. Louterman-Leloup, and P. Ruelle, *J. Chim. Phys. Phys.-Chim. Biol.*, in press.
- (15) G. Leroy, G. Louterman-Leloup, and P. Ruelle, *Bull. Soc. Chim. Belg.*, **85**, 205 (1976).
- (16) G. Leroy, G. Louterman-Leloup, and P. Ruelle, *Bull. Soc. Chim. Belg.*, **85**, 393 (1976).
- (17) G. Leroy and M. Sana, *Tetrahedron*, **32**, 709 (1976).
- (18) G. Leroy, M.-T. Nguyen, and M. Sana, *Tetrahedron*, **34**, 2459 (1978).
- (19) Proton slides analogous to this have been implicated in catalysis of the breakdown of tetrahedral intermediates (see, for example, P. Y. Bruice and T. C. Bruice, *J. Am. Chem. Soc.*, **96**, 5533 (1974)).
- (20) P. Caramella and K. N. Houk, *J. Am. Chem. Soc.*, **98**, 6397 (1976).
- (21) P. Caramella, R. W. Gandour, J. A. Hall, C. G. Deville, and K. N. Houk, *J. Am. Chem. Soc.*, **99**, 385 (1977).
- (22) R. W. Strozier, P. Caramella, and K. N. Houk, *J. Am. Chem. Soc.*, **101**, 1342 (1979).
- (23) K. N. Houk, private communication.
- (24) G. Leroy and M. Sana, *Tetrahedron*, **31**, 2091 (1975).